

INTERNATIONAL CENTRE FOR AUTOMOTIVE TECHNOLOGY

[A Division of NATRiP Implementation Society (NATIS), Govt. of India]

Non-Transferable

TEST REPORT (DEVELOPMENT TEST)

Test Report No.: C D 0 G P 8 2 9 6



Date: 26.10.2020

- 1.0 NAME AND ADDRESS OF THE CUSTOMER : M/s. COMPUTECH SYSTEMS
G-4 ,Harsha House ,Karampura Complex ,
New Delhi- 110015 , India
- 1.1 NAME AND ADDRESS OF THE MANUFACTURER : Same as Sr. No. 1.0
- 2.0 CUSTOMER LETTER REF : IOCS No. CCDCOMSPLEEL126953 Dated 16-Oct-2020

3.0 DESCRIPTION OF DEVICE UNDER TEST (DUT):

DUT Name	Battery Module, 20.8V
Battery Type	LiFePo4
Battery Capacity(Ah)	24Ah (Ah in 5 hrs)
Rated Voltage	20.8 V DC
Id/Model No.	8S8P 25V24AH(LFP)
Quantity	02 Nos. of Battery Pack (ICAT/EEL/126953/01-02)
Trade Name	iPower
Drawing No.	Assem12
Configuration of cell	8S8P

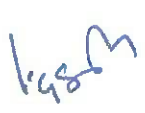
- 4.0 DATE OF RECEIPT OF SAMPLE: 19.10.2020
- 5.0 CONDITION OF SAMPLE : No physical damage observed.
- 6.0 TEST OBJECTIVE: To carry out the tests on the test samples as per customer's request.
- 7.0 TEST METHOD : As per customer request.
- 8.0 ANY DEVIATION OR EXCLUSION FROM TEST METHOD: Not Applicable.
- 9.0 FUNCTIONAL VERIFICATION : Functional verification done and was found satisfactory.
- 10.0 OBSERVATION: The battery described in Sr.No.3.0 of this test report met short circuit and overcharge test requirements as per customer request.
- 11.0 TEST DESCRIPTION: Please refer the Annexure-I of this report.
- 12.0 LOCATION OF TEST: ICAT CENTRE-I.
- 13.0 DATE OF PERFORMANCE OF TEST: Please refer the Annexure-I this report.
- 14.0 TEST RESULTS: Please refer the Test requirements and Results in Annexure-I of this report.

Prepared By	Checked By	Approved By
		
GIRISH SINGH Dy. Manager	MAHENDAR PAL Asst. General Manager	PAMEEA TIKKU Sr. General Manager







Page
01 of 03
+
Dwg. (01)
[126953]

DISCLAIMER

1. ICAT issues Test reports/ Extension reports/ Developmental Reports for vehicles/ parts/ components/ assemblies etc. based on the documents produced and/or prototype / vehicle(s) or sample(s) submitted by the applicant and testing thereof.
2. ICAT issues Test reports/ Extension reports/ Developmental Reports in compliance to Motor Vehicle Act/ Central Motor Vehicle Rules and their provisions as amended from time to time or any other statutory orders under which ICAT is authorized. Other Rules/Acts are outside the purview/scope of the Test reports/Extension reports/ Developmental test reports
3. Test(s) on prototype/ vehicle(s)/ sample(s) is/are carried out on the basis of standard procedures as notified under specific rules/ requested by the applicant. Results of such tests are property of bearer of Test Reports/ Extension Reports / Developmental test reports. These results cannot be disclosed unless specifically so ordered by Government, Court, etc
4. Unless otherwise supported by a separate Certificate, this Test report Extension Reports / Developmental test reports shall not be considered in isolation as valid Type approval for any vehicle
5. ICAT is not responsible for testing each vehicles/ parts/assemblies etc. for which Test Reports/ Extension reports/ Developmental test reports is issued. Further, ICAT is not responsible for ensuring manufacturing quality of the vehicles/ components/ parts/ assemblies etc. for which the Test Reports/ Extension reports/ Developmental test reports is /are issued.
6. ICAT is no way responsible for any misuse or copying any design/type/system in connection with entire vehicle/ components/parts and assemblies covered under the Test Reports/ Extension reports/ Developmental test reports is /are issued
7. Breach of any statutory provisions, of Indian laws or laws of other countries, will be sole responsibility of the customer. ICAT shall not be liable for any claims or damages made by the customer, whatsoever. The customer shall alone be liable for the same and undertakes to indemnify ICAT in this regard
8. Further, ICAT has the right, but not under obligation to initiate cancellation / withdrawal of the Test report/Extension/ Developmental test report is/are issued, in case of any fraud, misrepresentation, when it surfaces and comes in the knowledge of ICAT
9. No extract, abridgment or abstraction from this test report may be published or used to advertise the product without the written consent of the Director, ICAT, who reserves the absolute right to agree or reject all or any of the details of any items of publicity for which consent may be sought The appropriate local court at Gurugram shall have the jurisdiction in respect of any dispute, claim or liability arising out of this report.

Prepared By		Checked By	
 GIRISH SINGH Dy. Manager		 MAHENDAR PAL Asst. General Manager	Page 02 of 03 + Dwg(01) [126953]



Test Report No.: C D 0 G P 8 2 9 6

Date: 26.10.2020

Annexure-I

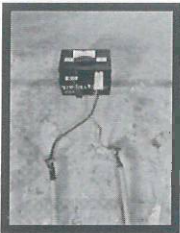
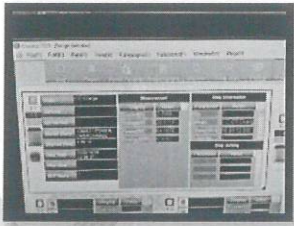
1.0 TEST REQUIREMENTS AND RESULTS:

Sr. No.	Test	Test Description	Observations/Results
Mechanical Tests			
1.0	<p>Over Charge test (Test ID:ICAT/EEL /126953/01) Date of Test : 20.10.2020</p>	 <p>Battery Condition: Fully charged (100% SOC), contained at ambient temperature at 27±5°C. Duration: 10 hours The cell is to be overcharged at a constant charging current of 0.1 (C₁₀). Acceptance Criteria: At the end of the test, there shall be no: a) Physical damage to the casing or other mechanical parts. b) Melting of components. c) Fire or explosion</p>	<p>Battery cell was charged with 2.4 A for 10 hours.</p> <p>No physical damage, melting or explosion observed.</p> <p>Satisfactory</p>
2.0	<p>Short Circuit test (Test ID:ICAT/EEL /126953/04) Date of Test : 20.10.2020</p>	  <p>Battery Condition: Fully charged (100% SOC), contained at ambient temperature. Apply a hard short in less than one second to the battery module with a conductor specified in the standard. Test Duration: 10 minutes, or until another condition occurs which prevents completion of test (i.e. component melting, etc.) Lab temperature: Not exceeding 30°C Acceptance Criteria: After 2 hours of observation: At the end of the test, there shall be no: a) Physical damage to the casing or mechanical parts. b) Melting of components. c) Fire or explosion. It is acceptable for the battery to become dry at the end of the test.</p>	<p>Ambient temperature : 27°C</p> <p>Conductor of ≤ 5mΩ was used and short was applied for 10 minutes.</p> <p>No physical damage, explosion or melting observed.</p> <p>Satisfactory.</p>

Prepared By		Checked By	Page 03 of 03 + Dwg(01) [126953]
 GIRISH SINGH Dy. Manager		 MAHENDAR PAL Asst. General Manager	

2

Test report nos- CD06P8296 Dated:- 26-10-2020

SIZE 215*169*127
(L*W*H) TOLERANCE
0 MM

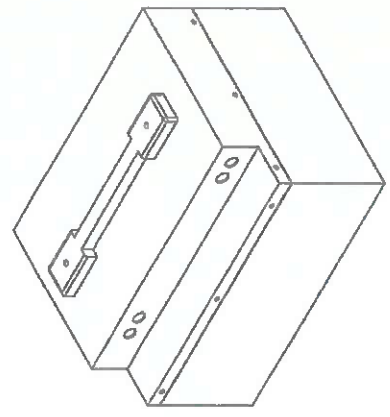

B

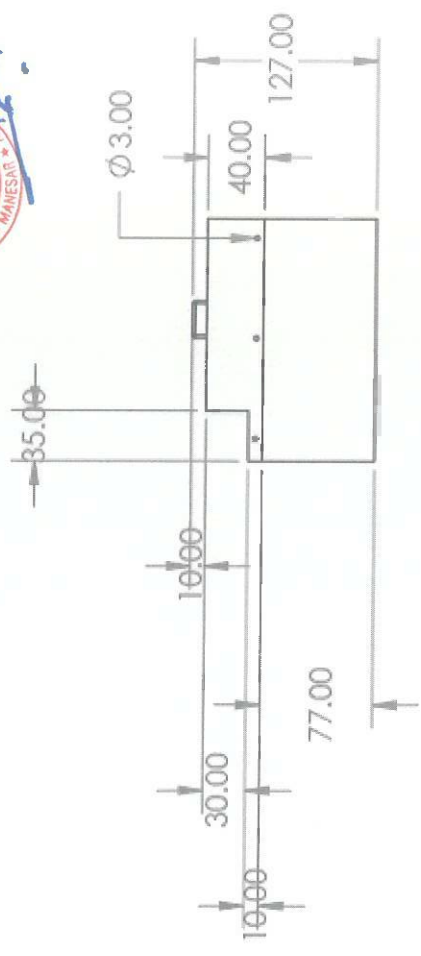
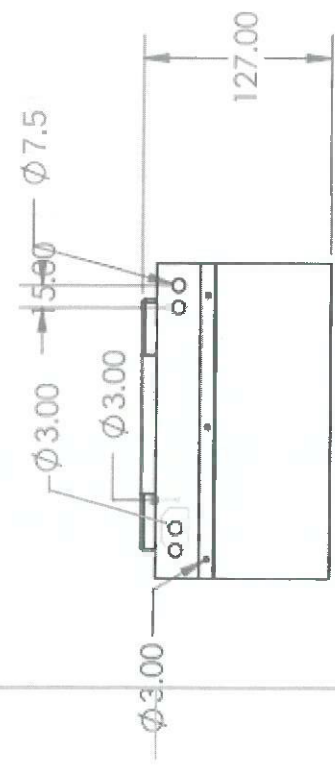
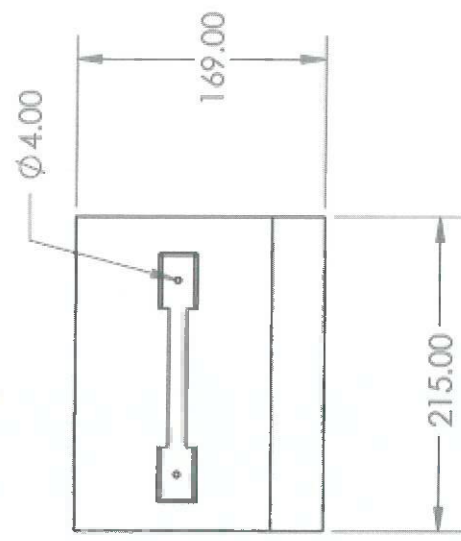

B

A

UNLESS OTHERWISE SPECIFIED: DIMENSIONS ARE IN MM TOLERANCES: FRACTIONAL ± ANGULAR: MACH ± BEND ± TWO PLACE DECIMAL ± THREE PLACE DECIMAL ±		DRAWN	NAME	DATE
INTERPRET GEOMETRIC TOLERANCING PRE- MATERIAL FINISH		CHECKED		
DO NOT SCALE DRAWING		ENG APPR.		
APPLICATION		MFG APPR.		
NEXT ASSY		G.A.		
USED ON		COMMENT: BATTERY CAPACITY- 24AH RATED VOLTAGE- 25.6V CONFIGURATION OF CELL- 8S8P		
PROHIBITED		TRADE NAME- IPOWER BATTERIES		
THE INFORMATION CONTAINED IN THIS DRAWING IS THE SOLE PROPERTY OF <INSERT COMPANY NAME HERE>. ANY REPRODUCTION IN PART OR AS A WHOLE WITHOUT THE WRITTEN PERMISSION OF <INSERT COMPANY NAME HERE> IS PROHIBITED.		TITLE: CUSTOMER NAME- COMPUTECH SYSTEMS MANUFACTURE NAME- COMPUTECH SYSTEMS MAKE- IPOWER BATTERY TYPE- LiFePO4 TRACTION BATTERY ID/ MODEL NO.- 8S8P 25.6V24Ah (LFP)		
NEXT ASSY		SIZE DWG. NO. REV		
USED ON		A Assem12 REV		
APPLICATION		SCALE: 1:5 WEIGHT: SHEET 1 OF 1		

2

1

Page 1 of 1